

# Shower Enclosures

by AIS



**Shower Enclosures**  
Redefining Spaces



**Shower Enclosures**  
Redefining Spaces

[www.aiswindows.com](http://www.aiswindows.com)

Follow us on:     



To experience glass like never before, download the AIS app now!

April - 2026

**Step into a pristine experience.**

**AIS WINDOWS – A DIVISION OF ASAHI INDIA GLASS LTD.**



Asahi India Glass Ltd.

Asahi India Glass Ltd. (AIS) is India's leading integrated glass and window solutions company and a dominant player both in the automotive and building & construction segments. Our product solutions, spanning the entire breadth of automotive, building & construction, and consumer glass, are designed to deliver aesthetic and functional benefits.

## We are delighted to introduce the all-new Shower Enclosures

an addition to our ever-growing portfolio  
of innovative glass offerings.

# Shower enclosures that redefine spaces



AIS Shower Enclosures combine form and function to creatively tailor to individual tastes and requirements. Our core product is the frameless shower enclosures that open new, elegant avenues in bathroom design with its unique transparent structure.

Made with the highest-quality materials and finish, our shower enclosures are built to withstand extreme forces, ensuring an exceptional product offering in the market.

# Why are AIS Shower Enclosures the best choice?

## Custom Made

Personalised design as per bathroom requirements



## World-Class Hardware

- Brass & Stainless Steel hinges for an enhanced aesthetic appeal
- Soft-close hinges with automatic closure from 30-degree angle for impact protection



## Extremely Safe Glass

Toughened glass adhering to IS 2553 Part 1 & EN 12150-1 Standards



## The AIS Advantage

A legacy built on clarity and strength with years of expertise in glass innovation

## Leak Proof

With water retention properties tested as per EN-14428:2015 Standards



## Doorstep Installation

Thorough installation and handover by the AIS service team

## Shower Protect Technology

Non-stick, easy-clean coating that resists limescale and bacteria for effortless maintenance and improved hygiene



A single glass panel is placed on the outside of the shower space, enabling entry from one side of the area

### ONE FIXED GLASS



A single glass door opens to provide direct entry into the shower space

### SINGLE GLASS DOOR

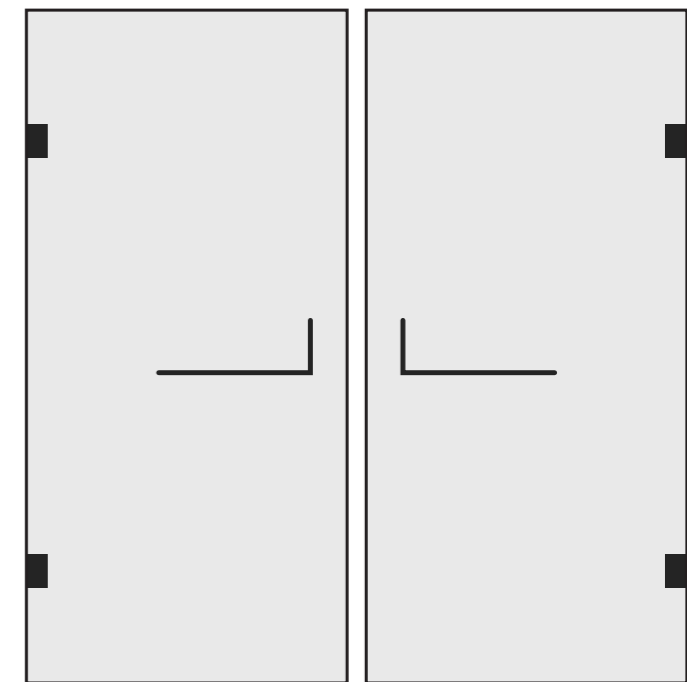

Images and diagrams are for illustrative and reference purposes only. Actual products may vary.

\*All hardware finishes are available in Chrome, Matte Black, and Rose Gold across all configurations.



A fixed glass panel alongside a hinged glass door, which opens to provide direct entry into the shower space

A swinging glass door is positioned between two fixed glass panels for central entry to the shower space

### ONE FIXED GLASS AND ONE DOOR

1 RIGHT DOOR +  
1 FIXED GLASS  
(WALL TO  
GLASS HINGE)

1 LEFT DOOR +  
1 FIXED GLASS  
(WALL TO  
GLASS HINGE)

1 LEFT DOOR +  
1 FIXED GLASS  
(GLASS TO  
GLASS HINGE)

1 RIGHT DOOR +  
1 FIXED GLASS  
(GLASS TO  
GLASS HINGE)

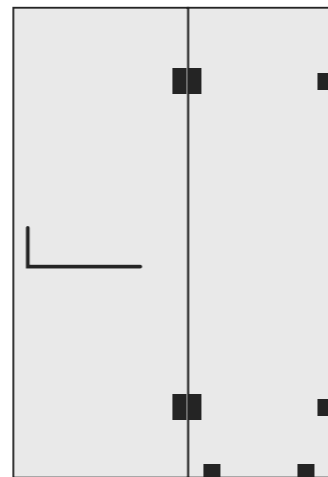
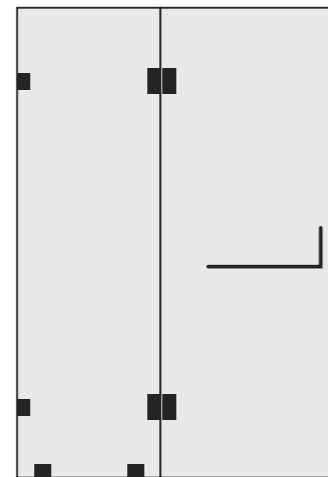
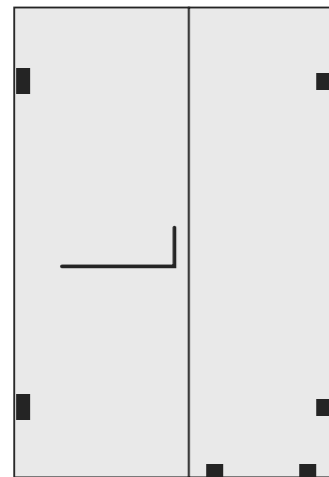
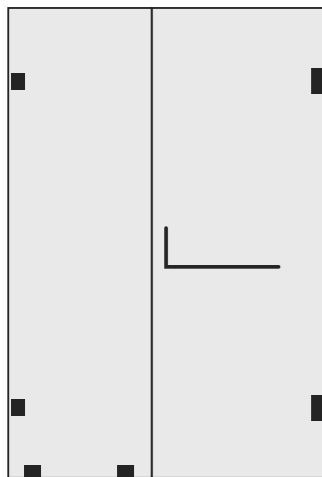

### TWO FIXED GLASS AND ONE DOOR

1 MIDDLE RIGHT DOOR + 2 FIXED GLASS  
(GLASS TO GLASS HINGE)

1 MIDDLE LEFT DOOR + 2 FIXED GLASS  
(GLASS TO GLASS HINGE)

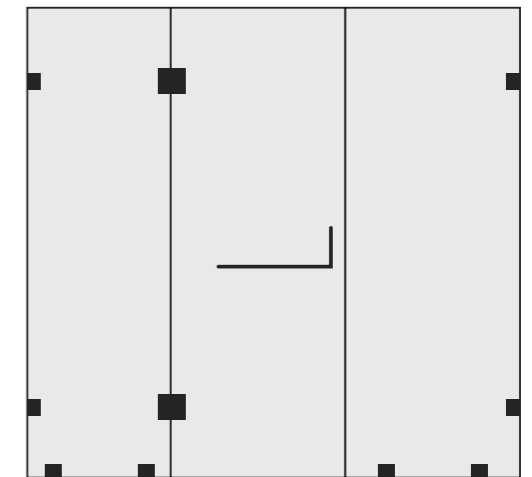
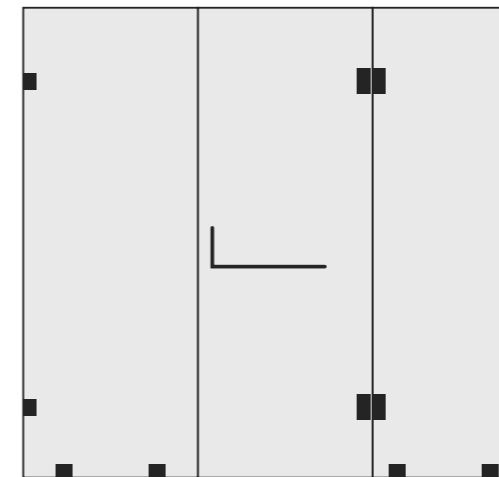

Images and diagrams are for illustrative and reference purposes only. Actual products may vary.

\*All hardware finishes are available in Chrome, Matte Black, and Rose Gold across all configurations.

Images and diagrams are for illustrative and reference purposes only. Actual products may vary.

\*All hardware finishes are available in Chrome, Matte Black, and Rose Gold across all configurations.



A glass door is beside a fixed glass panel, swinging open for access from only one side of the shower enclosure area



L shaped shower enclosure with 2 fixed panels and 1 glass door that opens to provide entry into the shower space

**ONE FIXED GLASS AND ONE DOOR**

**LEFT DOOR +  
1 FIXED GLASS (L SHAPE)**

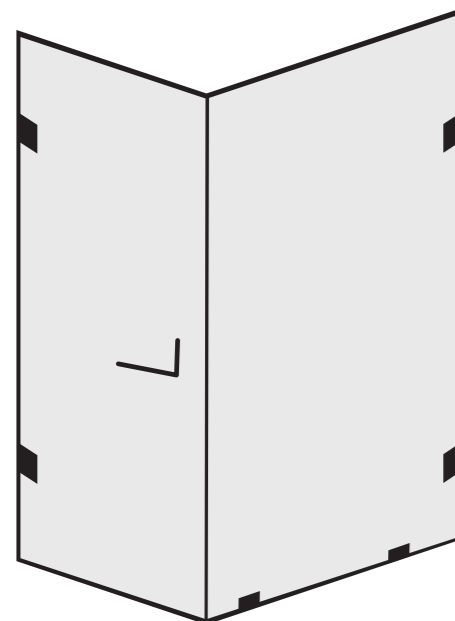

**RIGHT DOOR +  
1 FIXED GLASS (L SHAPE)**

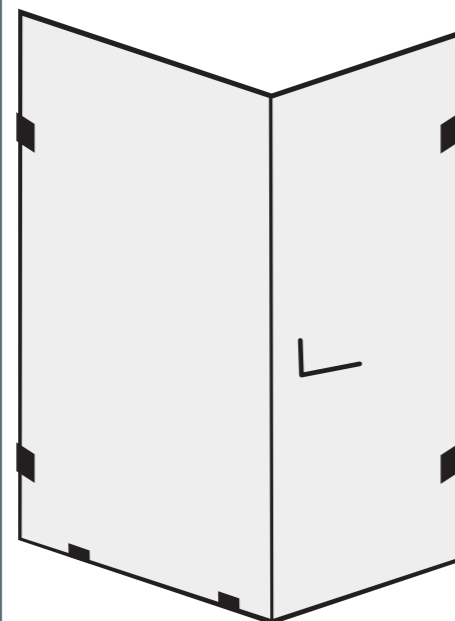

**1 RIGHT DOOR+ 1 FIXED GLASS  
(WITH 90° GLASS TO GLASS  
HINGE) L SHAPE**

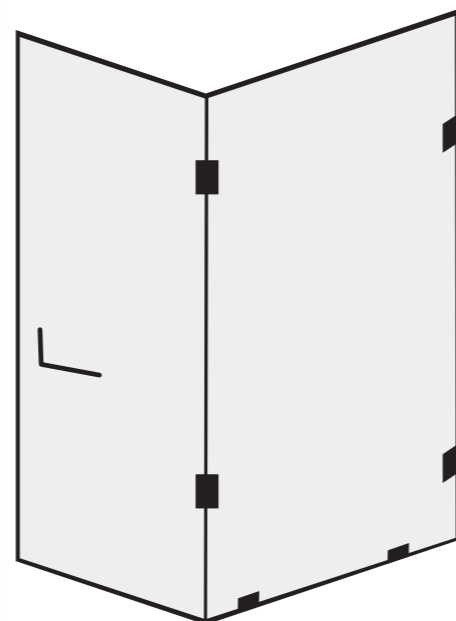

**TWO FIXED GLASS AND ONE DOOR**

**1 RIGHT DOOR + 2 FIXED GLASS  
(WITH WALL TO GLASS HINGE)  
L SHAPE**

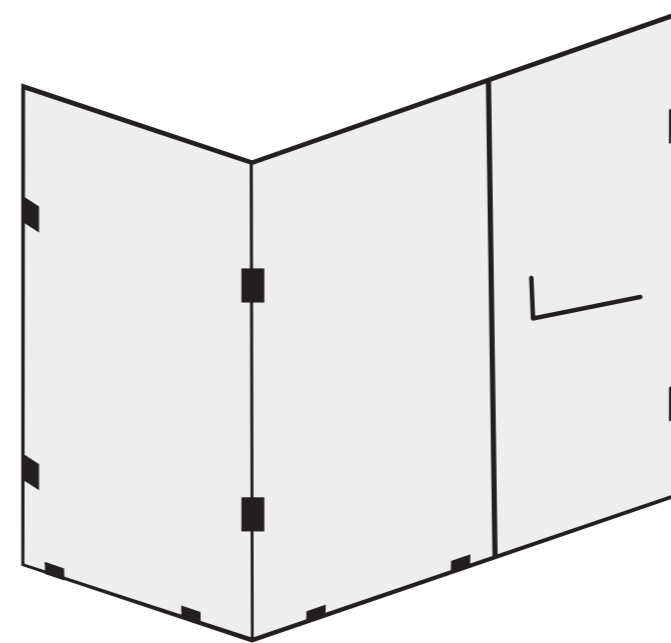

**TWO FIXED GLASS AND ONE DOOR**

**1 RIGHT DOOR + 2 FIXED GLASS  
(WITH GLASS TO GLASS HINGE)  
L SHAPE**

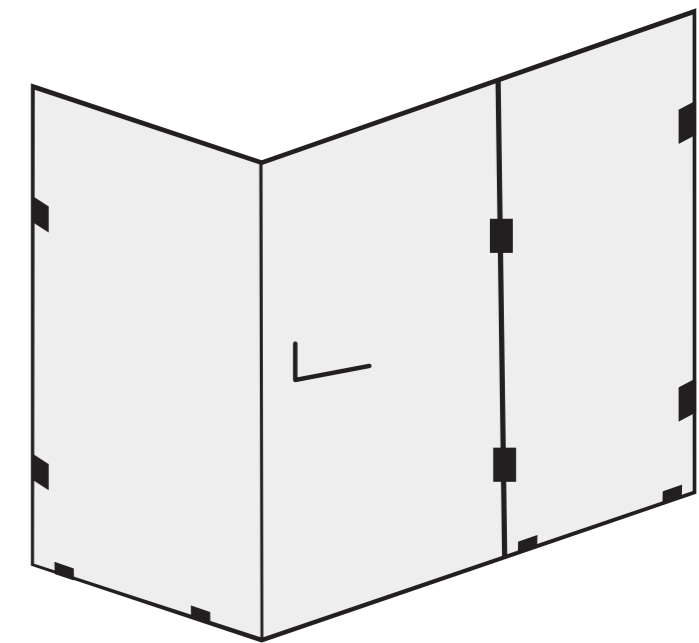

*Images and diagrams are for illustrative and reference purposes only. Actual products may vary.*

*\*All hardware finishes are available in Chrome, Matte Black, and Rose Gold across all configurations.*

*Images and diagrams are for illustrative and reference purposes only. Actual products may vary.*

*\*All hardware finishes are available in Chrome, Matte Black, and Rose Gold across all configurations.*



A glass door is beside a fixed glass panel, swinging open for access from only one side of the shower enclosure area



A C-shaped enclosure surrounds the shower area with a door opening from one side

**TWO FIXED GLASS AND ONE DOOR**

**1 LEFT DOOR+ 2 FIXED GLASS (WITH 90° WALL TO GLASS HINGE) L SHAPE**

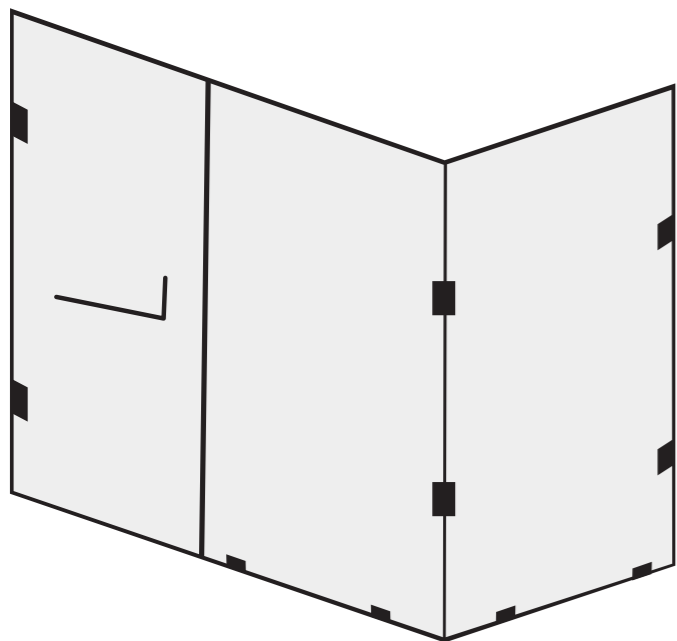

**LEFT MIDDLE DOOR+ 2 FIXED GLASS (WITH 90° GLASS TO GLASS HINGE) L SHAPE**

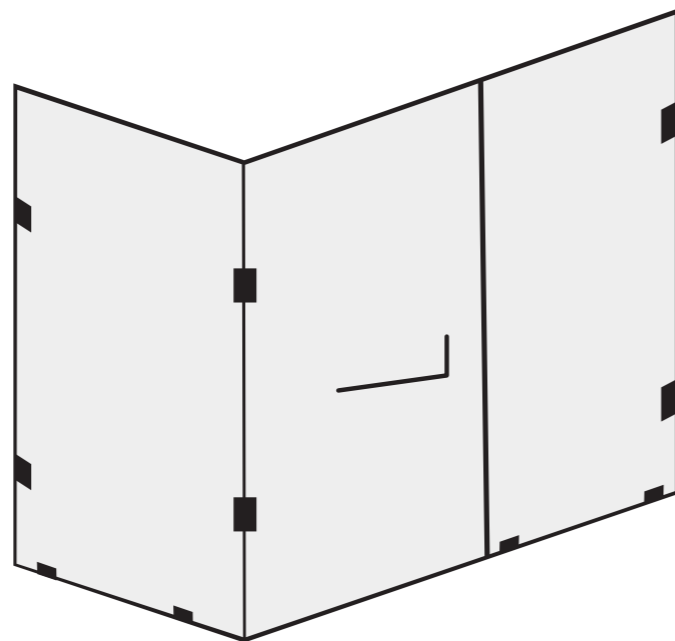

**THREE FIXED GLASS AND ONE DOOR**

**1 RIGHT DOOR+ 3 FIXED GLASS (WITH 90° GLASS TO GLASS HINGE) C SHAPE**

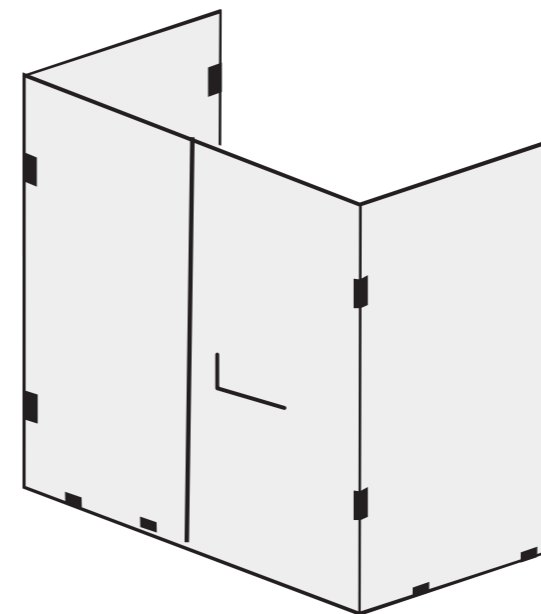

**1 LEFT DOOR+ 3 FIXED GLASS (WITH 90° GLASS TO GLASS HINGE) C SHAPE**

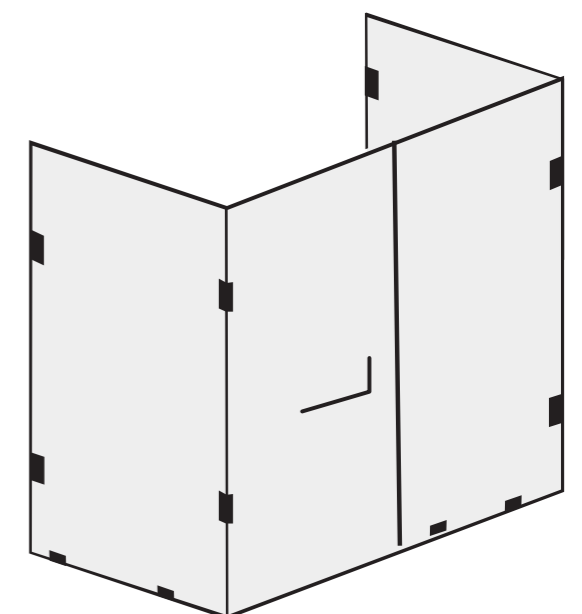

Images and diagrams are for illustrative and reference purposes only. Actual products may vary.

\*All hardware finishes are available in Chrome, Matte Black, and Rose Gold across all configurations.

Images and diagrams are for illustrative and reference purposes only. Actual products may vary.

\*All hardware finishes are available in Chrome, Matte Black, and Rose Gold across all configurations.



A large enclosure with fixed panels on both sides and a door in the middle provides entry into the shower space



Doors positioned on both sides with fixed panels create a T-shaped enclosure with dual entry

**FOUR FIXED GLASS AND ONE DOOR**

**1 RIGHT DOOR+ 4 FIXED GLASS  
(WITH 180° GLASS TO GLASS HINGE)  
C SHAPE**

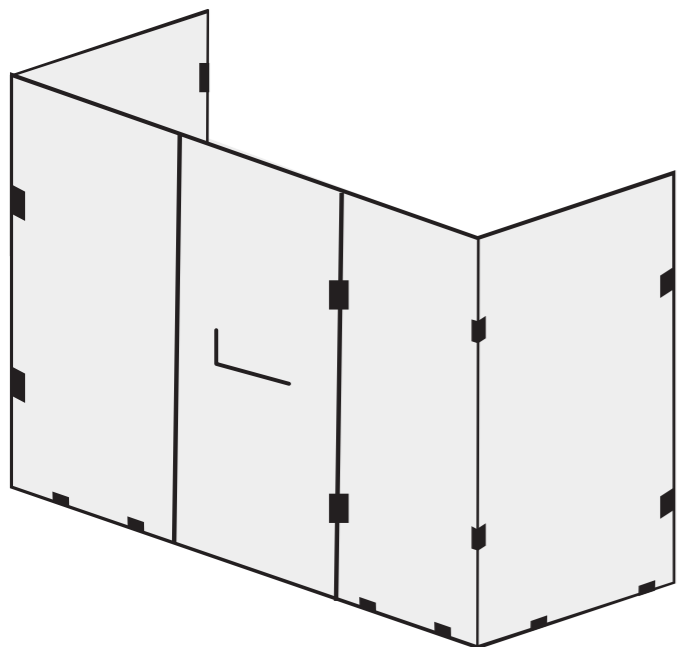

**FOUR FIXED GLASS AND ONE DOOR**

**1 LEFT DOOR+ 4 FIXED GLASS  
(WITH 180° GLASS TO GLASS HINGE)  
C SHAPE**

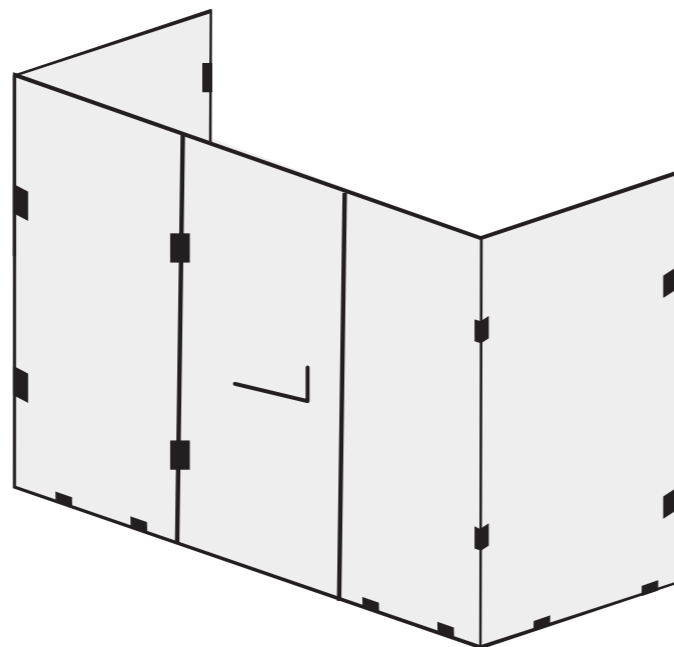

**THREE FIXED GLASS AND TWO DOORS**

**2 MIDDLE DOORS+ 3 FIXED GLASS  
(WITH GLASS TO GLASS HINGE  
AND 3 WAY CONNECTORS)  
T SHAPE**

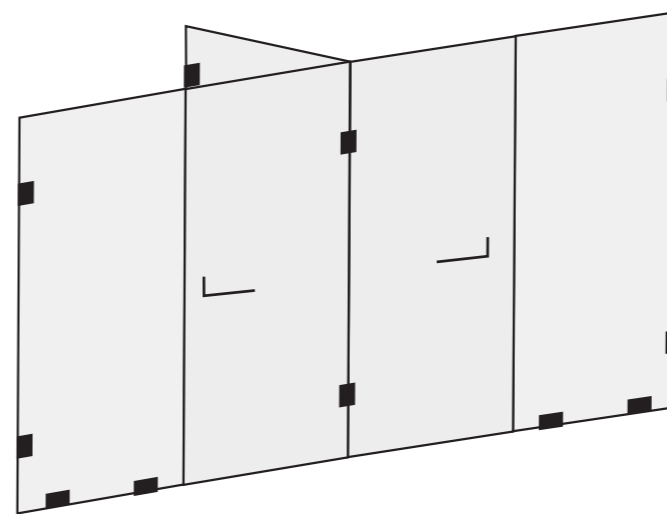

**2 SIDE DOORS + 3 FIXED GLASS  
(WITH GLASS TO GLASS HINGE  
AND 3 WAY CONNECTORS)  
T SHAPE**

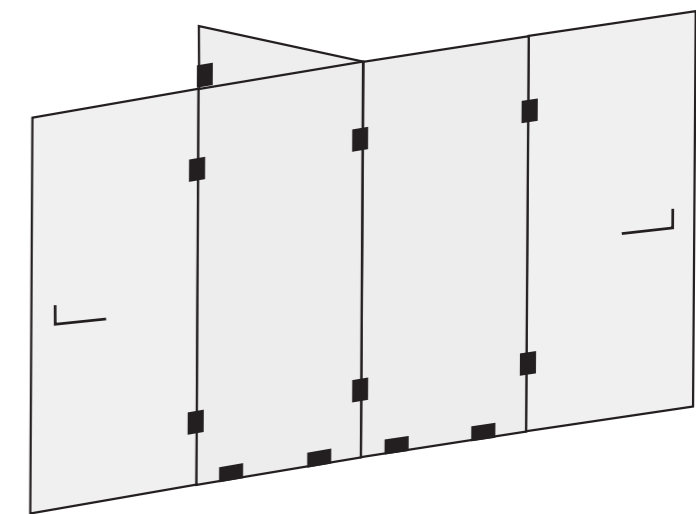

Images and diagrams are for illustrative and reference purposes only. Actual products may vary.

\*All hardware finishes are available in Chrome, Matte Black, and Rose Gold across all configurations.

Images and diagrams are for illustrative and reference purposes only. Actual products may vary.

\*All hardware finishes are available in Chrome, Matte Black, and Rose Gold across all configurations.



A sliding door moves along a fixed panel, allowing entry from one side



A sliding door with fixed panels on both sides forms a wider enclosure with single-side access

### ONE FIXED GLASS AND ONE SLIDING DOOR

1 FIXED GLASS + 1 SLIDING DOOR  
(LEFT SLIDING)

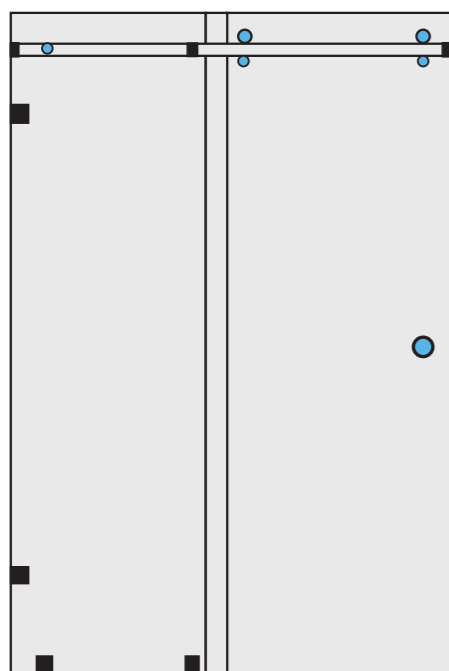

1 FIXED GLASS + 1 SLIDING DOOR  
(RIGHT SLIDING)

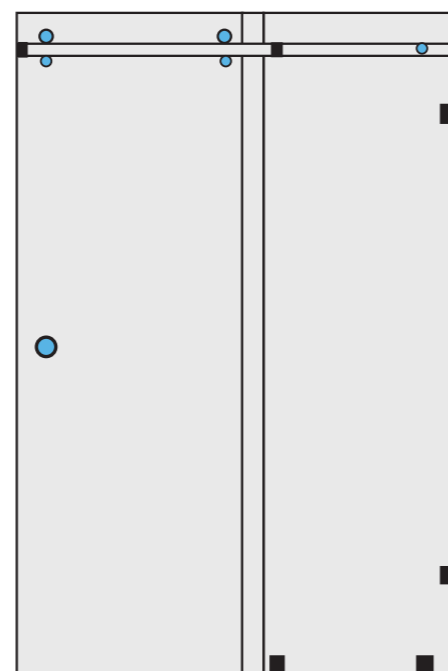

Images and diagrams are for illustrative and reference purposes only. Actual products may vary.  
\*All hardware finishes are available in Chrome, Matte Black, and Rose Gold across all configurations.

### TWO FIXED GLASS AND ONE SLIDING DOOR

2 FIXED GLASS + 1 SLIDING DOOR  
(RIGHT SLIDING)

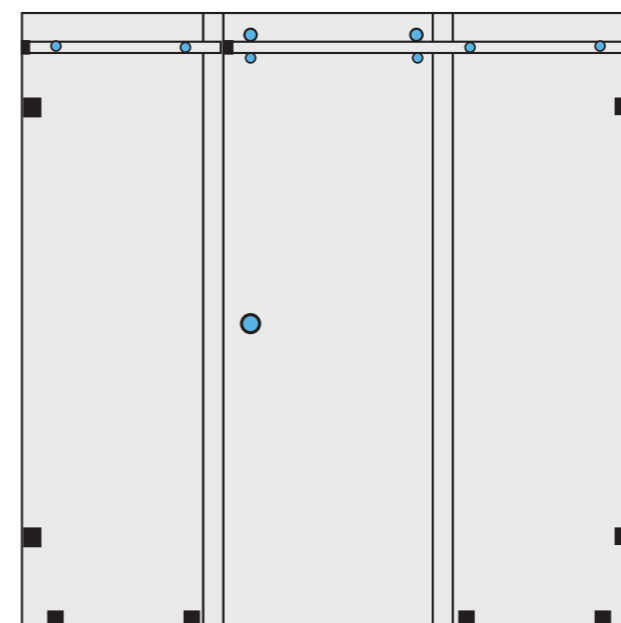

2 FIXED GLASS + 1 SLIDING DOOR  
(LEFT SLIDING)

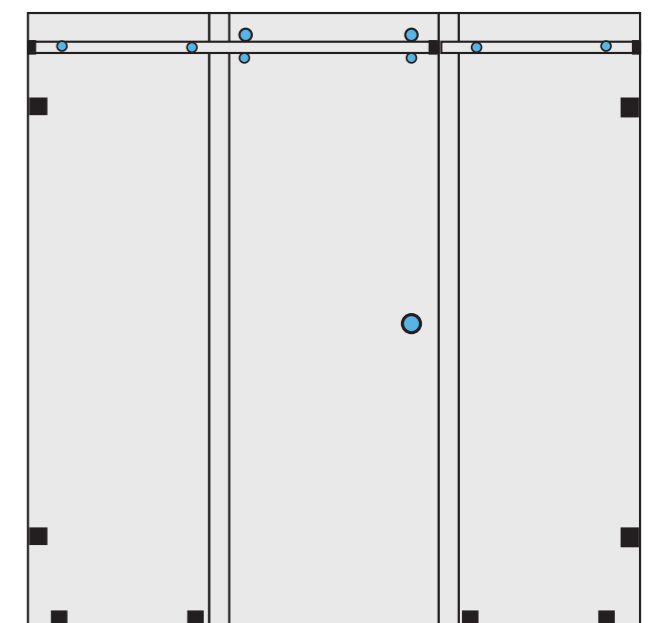

Images and diagrams are for illustrative and reference purposes only. Actual products may vary.  
\*All hardware finishes are available in Chrome, Matte Black, and Rose Gold across all configurations.



A corner sliding enclosure where the door moves along fixed panels for entry



Two sliding doors meet at the centre, allowing wide and convenient entry into the shower space

**TWO FIXED GLASS AND ONE SLIDING DOOR**

**2 FIXED GLASS + 1 LEFT SLIDING DOOR  
(90° WALL)**

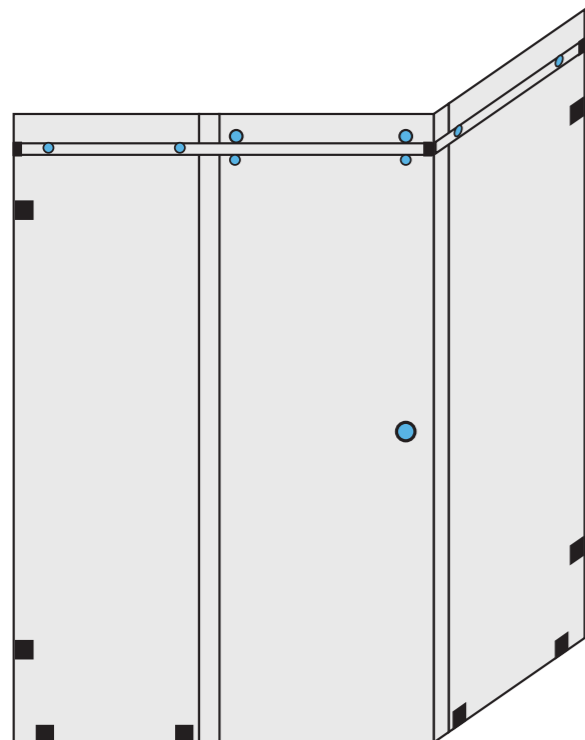

**2 FIXED GLASS + 1 RIGHT SLIDING DOOR  
(90° WALL)**

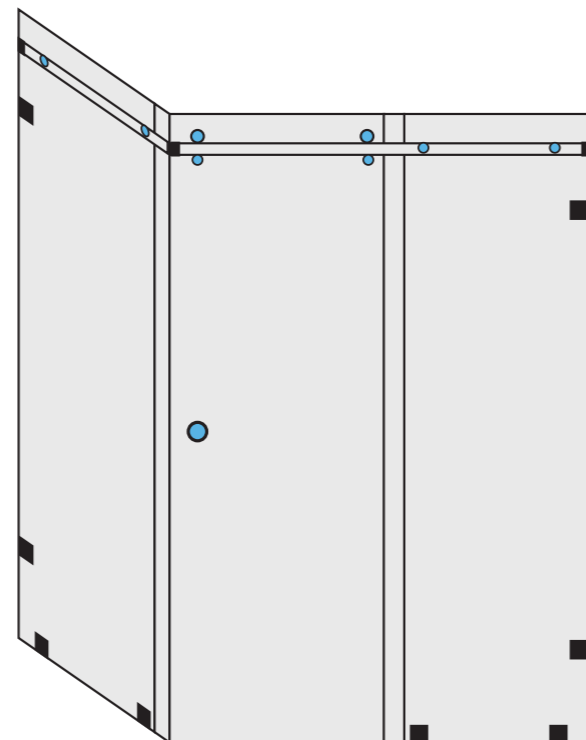

Images and diagrams are for illustrative and reference purposes only. Actual products may vary.  
 \*All hardware finishes are available in Chrome, Matte Black, and Rose Gold across all configurations.

**TWO FIXED GLASS AND TWO SLIDING DOOR**

**2 FIXED GLASS + 2 SLIDING DOORS**

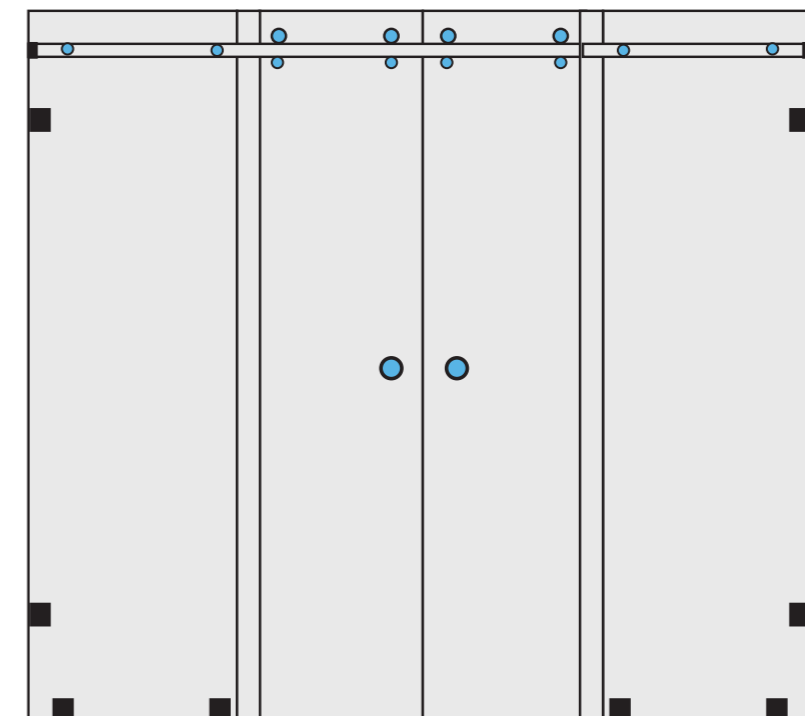



Images and diagrams are for illustrative and reference purposes only. Actual products may vary.  
 \*All hardware finishes are available in Chrome, Matte Black, and Rose Gold across all configurations.

# A premium glass solution for your spaces



As glass is a significant component in a shower enclosure, we ensure to use the highest quality of toughened glass that conforms to safety standards. We design our shower enclosures with industry-grade materials to bring you closer to a redefined bathing space.

-  5 times stronger than normal/annealed glass
-  Available in 8mm thickness
-  Shock and impact-resistant

## Glass options available:



Clear



Tinted

*\*All hardware finishes are available in Chrome, Matte Black, and Rose Gold across all configurations.*

# Shower Protect Technology



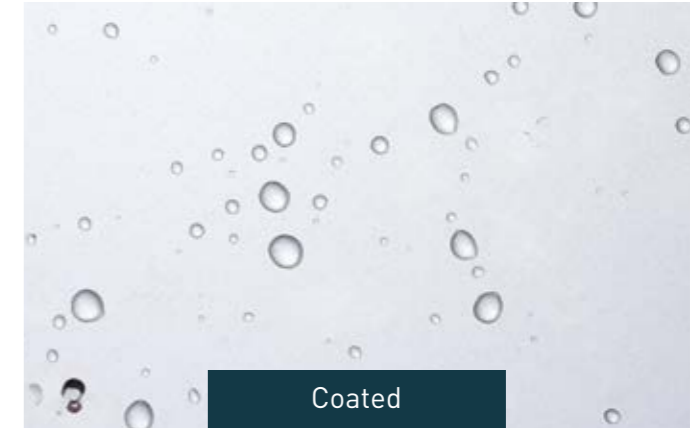
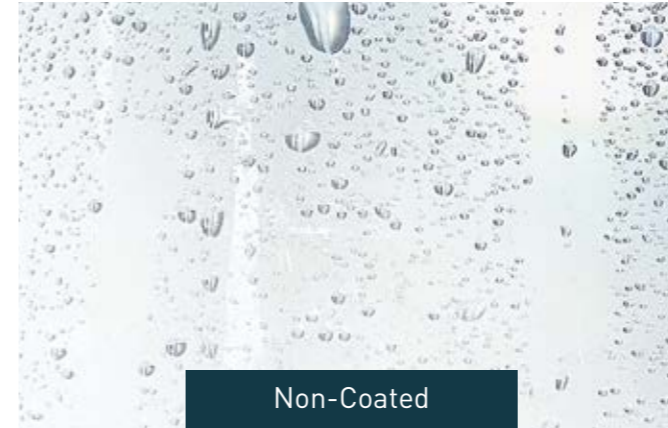



Cleaner, healthier spaces now made possible

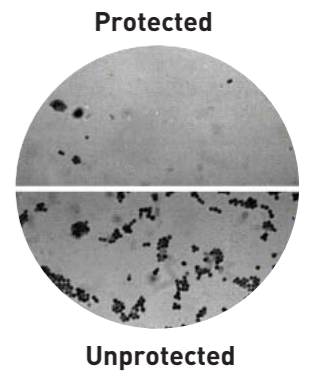

Typically, hard water usage results in water-resistant spots to appearing on unprotected glass, giving it an unappealing appearance. Additionally, limescale from the hard water etches itself onto the glass surface, with high levels of humidity accelerating the corrosion process.

Our easy-to-maintain shower enclosures are manufactured with an exceptional 'Shower Protect Technology' that surpasses normal glass with a variety of features to ensure its appearance and durability.



-  Durable, 'non-stick' anti-limescale protection
-  Resistant to the adhesion of bacteria, staining and corrosion for a more hygienic environment
-  Lowered impact of surface contamination for reduced maintenance
-  Saves cleaning time and effort
-  Optically clear glass for a pristine appearance
-  No need for harsh or abrasive cleaning products and methods



Experience the Shower Protect Technology

*\*Terms & conditions apply*

# HARDWARE FEATURES



ON HARDWARE

\*Terms & conditions apply

AIS Shower Enclosures are available in both brass and stainless-steel hardware options, for enhanced durability, corrosion resistance, and aesthetic flexibility.



Trendy and visually appealing hardware design



Hinges engineered for smooth pivot action and automatic closure around 30°



Stability tests carried out on hinge strength



Corrosion-resistant, rust-proof finishes to suit humid bathroom environments



Sealing

- Water resistance & heat insulation
- Robust impact tolerance
- Easy installation
- RoHS-compliant material
- Clear appearance that retains aesthetic value

Available in Three Signature Finishes Across All Hardware:



Polished Chrome



Matte Black



Rose Gold

\*All hardware finishes are available in Chrome, Matte Black, and Rose Gold across all configurations.

# AIS SHOWER ENCLOSURES



Images and diagrams are for illustrative and reference purposes only. Actual products may vary.

\*All hardware finishes are available in Chrome, Matte Black, and Rose Gold across all configurations.

## Hinges



Wall-to-Glass  
2-Way



90°  
Glass-to-Glass



180°  
Glass-to-Glass



3-Way



90°  
Glass-to-Glass

## Connectors



Fix-Clip  
Floor-to-Glass



90°  
Wall-to-Glass



90°  
Glass-to-Glass



180°  
Wall-to-Glass



180°  
Glass-to-Glass

## Headers



19mm Outer  
Diameter Pipe



Wall-to-End  
Connector



Pipe-to-Glass  
Connector



Angle-Adjustable  
Connector



T-Connector

## Door Handle



Round Towel Bar with Handle

## Glass Sealing



D Profile



Magnetic Profile

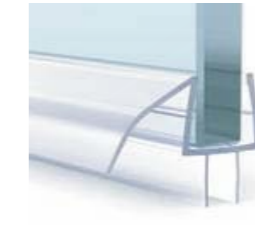

Water Dispenser



Y Profile

\*All hardware finishes are available in Chrome, Matte Black, and Rose Gold across all configurations.

\*All hardware finishes are available in Chrome, Matte Black, and Rose Gold across all configurations.





# QUALITY AND SAFETY FEATURES







Images and diagrams are for illustrative and reference purposes only. Actual products may vary.  
\*All hardware finishes are available in Chrome, Matte Black, and Rose Gold across all configurations.

As an industry benchmark, AIS Shower Enclosures adhere to strict international quality and safety standards.

## The Glass Conforms to Quality Checks as per IS 2553-1 and EN 12150-1 Standards

-  Visual tests for chipping, scratches, and any other visible defects
-  Ball drop test for impact resistance
-  Fragmentation test to check breakage pattern
-  Zebra test for vision waviness
-  Bow/bending test to ensure straightness of the glass

## Shower Enclosure Meets Quality Checks as per EN 14428:2015 Standards

-  Impact resistance ensures safety
-  Corrosion resistance provides durability
-  Endurance test enables increased life cycle
-  Stability guarantees resistance against human body impact
-  Water retention ensures a wet and dry area

# ENJOY OUR CUSTOMISED INSTALLATION SERVICE

From consultation to installation, we offer an end-to-end, hassle-free installation service of your shower enclosures from the comfort of your spaces.

## Mastering Glass Artistry

- AIS leads the industry with over 30 years of experience in glass processing.
- We excel in glass artistry, appreciating its significance in modern architecture and design.
- Our expertise enables us to showcase glass' versatility and visual appeal, making it a cornerstone of contemporary trends.

## Blending Functionality and Creativity

- AIS Shower Enclosures embody the perfect fusion of practicality and technical finesse.
- Each enclosure is crafted to satisfy practical requirements while reflecting modern lifestyles and artistic expression.

## Uncompromising Quality and Craftsmanship

- AIS products maintain the highest quality of standards and artisanship.
- Every enclosure is carefully constructed to achieve a balanced blend of form and function, customised to individual preferences.

## Innovative Frameless Shower Enclosures

- Each enclosure harmoniously merges form and function, tailored to individual tastes, to create a masterpiece in every space.

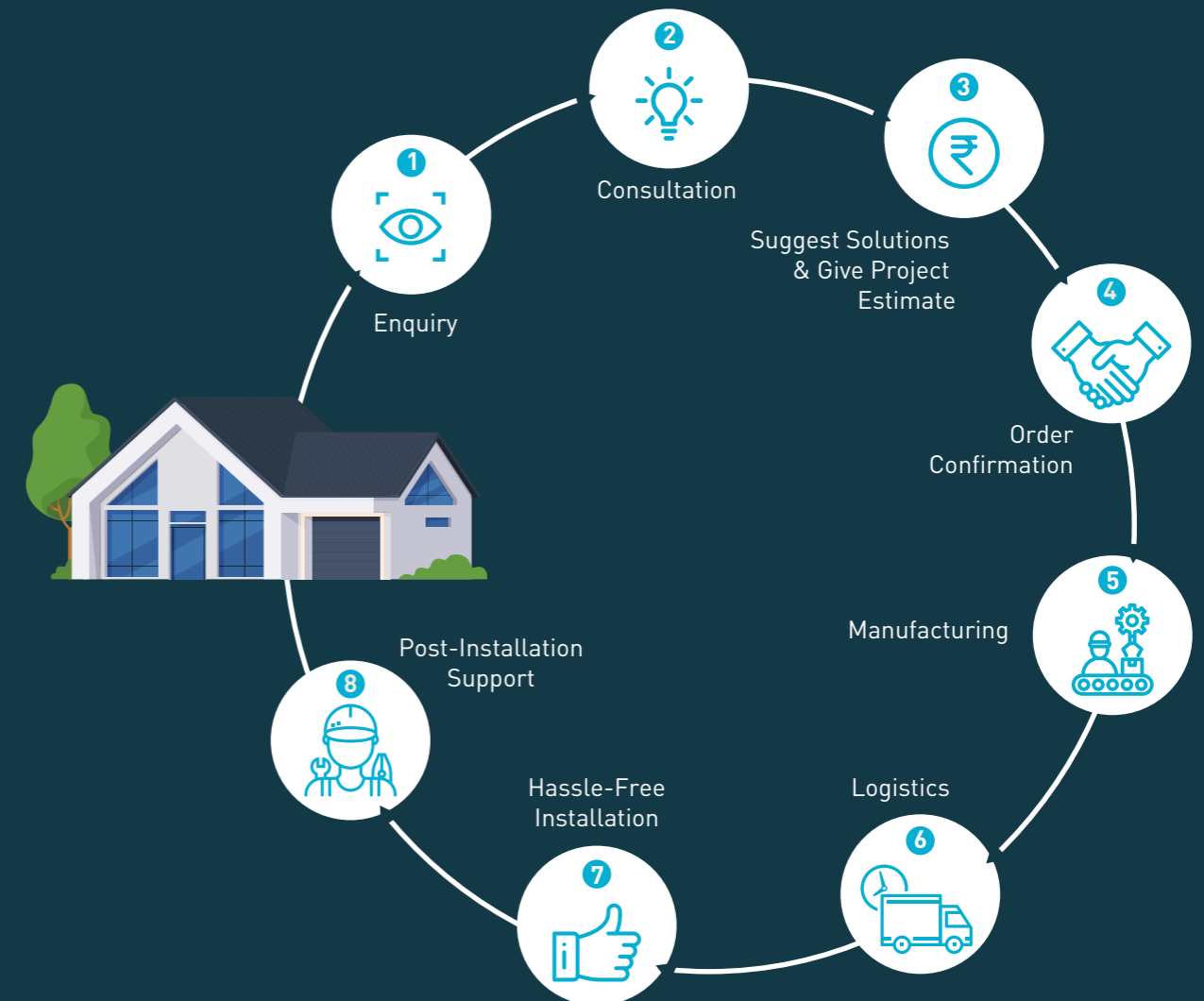

# 1800-103-4805

Call our customer care number for more details.

Timings: 10 AM to 8 PM every day (Except Holidays)

\*Terms & conditions apply